



SISTEMA 4 PERFILES





Ventana Corrediza

ENSAMBLE

ALTERNATIVAS DE DISEÑO

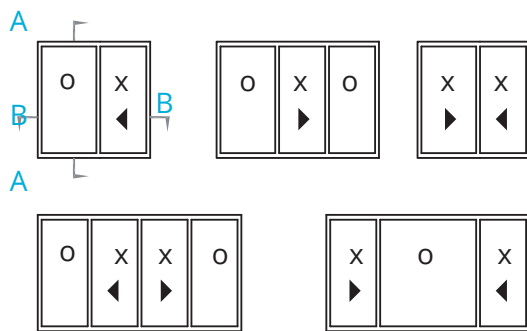

SECCIÓN VERTICAL (A - A)

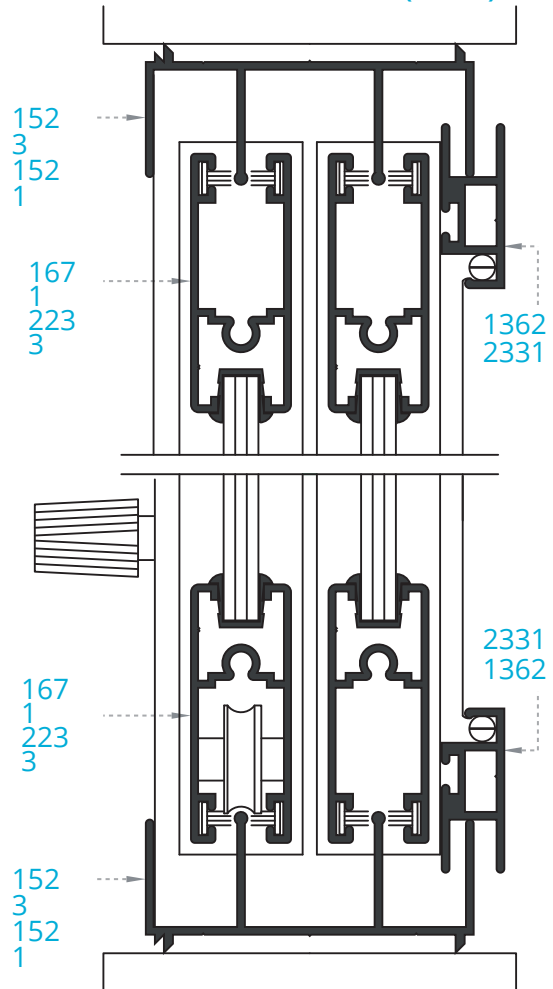

SECCIÓN HORIZONTAL (B - B)

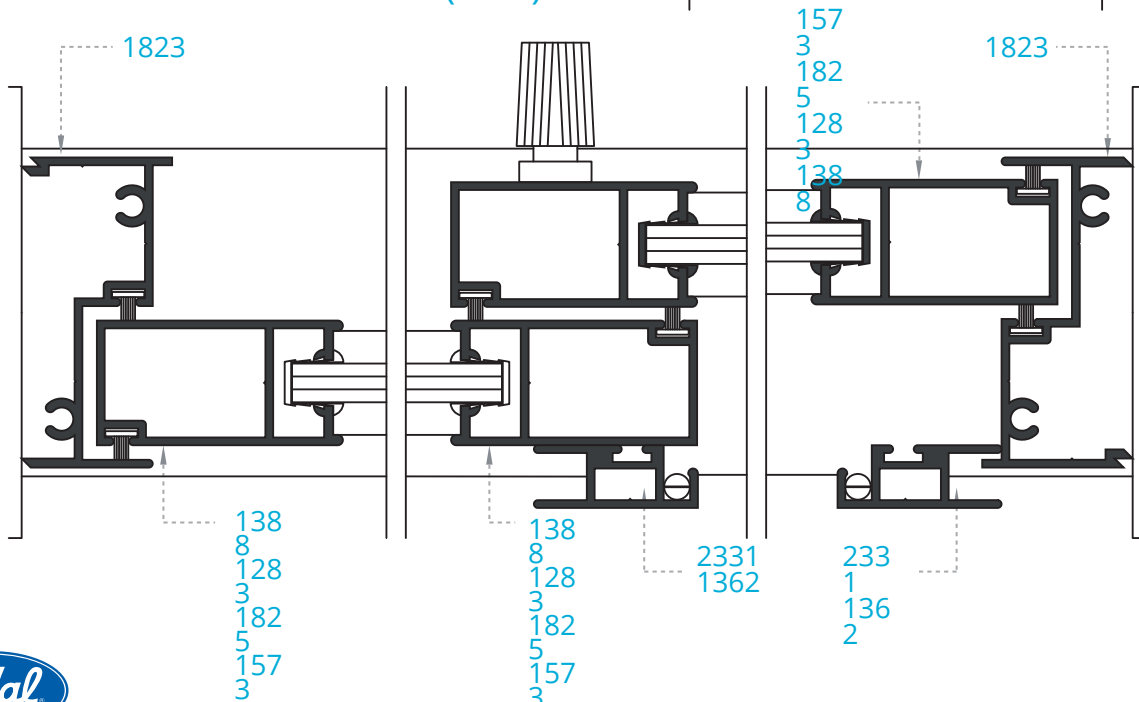



Ventana Corrediza

Escala: 1:1
Medida: Milímetros

REFERENCIAS

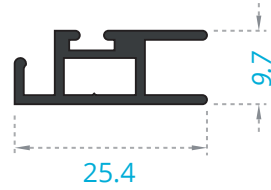
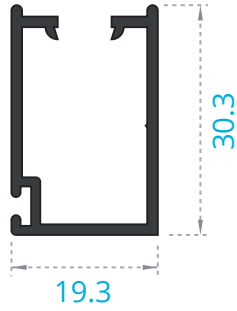

Nombre	Referencia	Peso
Vertical de Hoja Abierto	12830	349Kg/m.

Nombre	Referencia	Peso
Perfil de Malla	13620	239Kg/m.

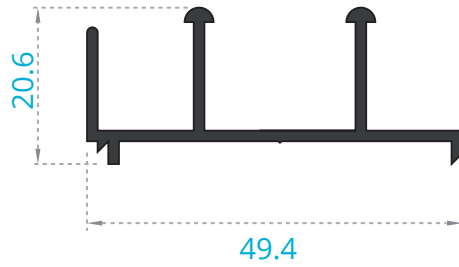
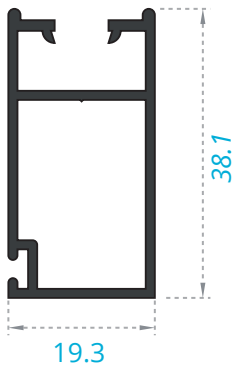

Nombre	Referencia	Peso
Vertical de Hoja Cerrado	13880	422Kg/m.

Nombre	Referencia	Peso
Riel Inferior	15210	401Kg/m.

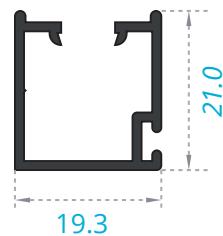
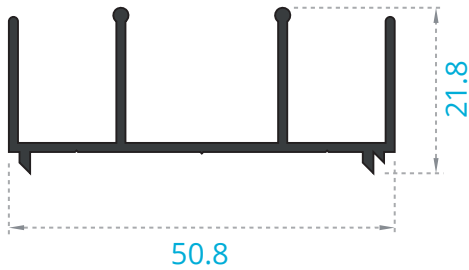

Nombre	Referencia	Peso
Riel Superior e Inferior	15230	411Kg/m.

Nombre	Referencia	Peso
Vertical de hoja Abierta	15730	250Kg/m.



Ventana Corrediza

Escala: 1:1
Medida: Milímetros

REFERENCIAS

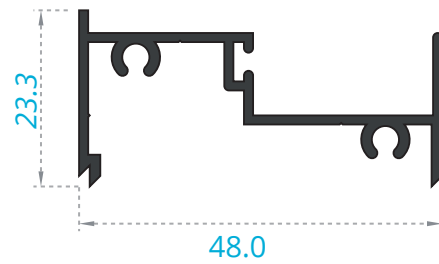
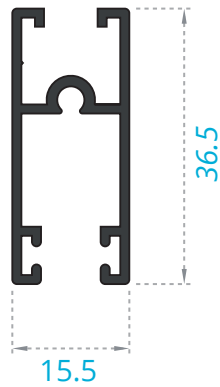

Nombre Referencia	Peso	
Horizontal de Hoja	16710.382Kg/m.	

Nombre Referencia	Peso	
Jamba Marco	18230.426Kg/m.	

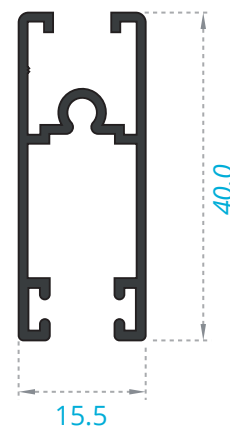
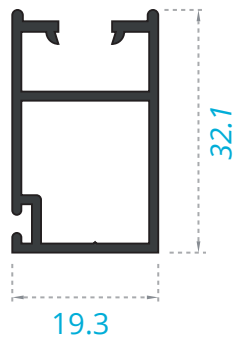

Nombre Referencia	Peso	
Vertical de Hoja Cerrado	18250.382Kg/m.	

Nombre Referencia	Peso	
Horizontal de Hoja	22330.388Kg/m.	

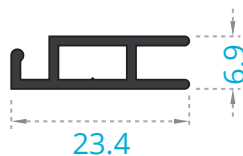

Nombre Referencia	Peso	
Malla Corrediza	23310.178Kg/m.	



Constrúyelo bien

